

# DECK & PAVER DRAINS

## 2" REMOVABLE TOP DECK DRAIN

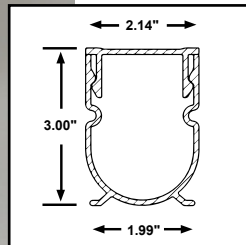

QP-6972



2" REMOVABLE TOP DRAIN MODEL NUMBERS  
Available colors: White, Gray, and Tan (W,G,T)

Item No.	Length	Packaging
QP-6972 (W,G,T)	10 ft.	80 ft./case, eight 10 ft. pcs.

*includes 4 adapters in a box of 8*

## 3" WATER HOG®



QP-6241

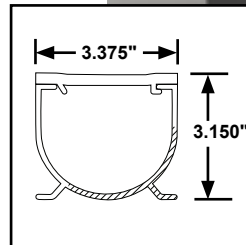

3" WATER HOG® MODEL NUMBERS  
Available colors: White, Gray, and Tan (W,G,T)

Item No.	Length	Packaging
QP-6241 (W,G,T)	6 ft.	48 ft./case, eight 6 ft. pcs.
QP-6242 (W,G,T)	10 ft.	60 ft./case, six 10 ft. pcs.

*Case includes connectors (8 pcs. in 6-ft. case, 6 pcs. in 10-ft. case), one extra screw packet, protective tape, and one instruction sheet. 6 ft is able to ship UPS, 10 ft is not.*

## 4" WATER HOG®



QP-6251

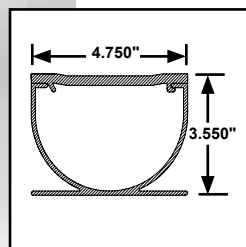

4" WATER HOG® MODEL NUMBERS  
Available colors: White, Gray, and Tan (W,G,T)

Item No.	Length	Packaging
QP-6251 (W,G,T)	6 ft.	24 ft./case, four 6 ft. pcs.
QP-6252 (W,G,T)	10 ft.	40 ft./case, four 10 ft. pcs.

*Case includes four connectors, one extra screw packet, protective tape, and one instruction sheet. 6 ft is able to ship UPS, 10 ft is not.*

## STREAMLINE | LOW PROFILE DRAIN

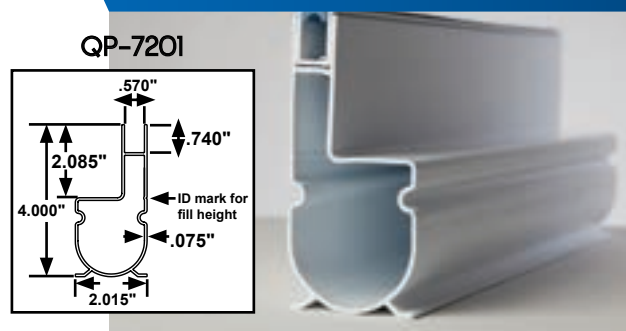

QP-7201

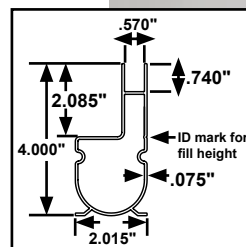

STREAMLINE MODEL NUMBERS  
Available colors: White, Gray, and Tan (W,G,T)

Item No.	Length	Packaging
QP-7201 (W,G,T)	8 ft.	48 ft./case, six 8 ft. pcs.

*Case includes six connectors and instruction sheet.*

## 2" SQUARE DRAIN SYSTEM



QP-5171

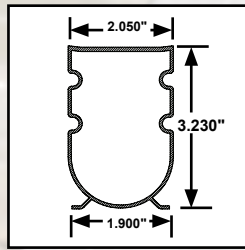

### 2" SQUARE DRAIN SYSTEM MODEL NUMBERS

Available colors: White, Gray, and Tan (W,G,T)

Item No.	Length	Packaging
<b>QP-5171</b> (W,G,T)	10 ft.	80 ft./case, eight 10 ft. pcs.

Includes eight connectors (QP-5981-1), two surface clean-out plugs (QP-988-1), double-protective tape, and one instruction sheet.

## DECK DRAIN-A-WAY® SYSTEM II



QP-3701

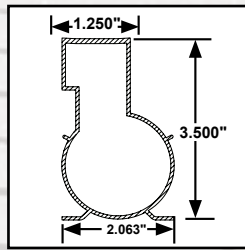

### DECK DRAIN-A-WAY® SYSTEM II MODEL NUMBERS

Available colors: White, Gray, and Tan (W,G,T)

Item No.	Length	Packaging
<b>QP-3701</b> (W,G,T)	8 ft.	72 ft./case, nine 8 ft. pcs.

Includes eight connectors (QP-5981-1), two surface clean-out plugs (QP-988-1), double-protective tape, and one instruction sheet.

## 2" PAVER DRAIN



QP-6401

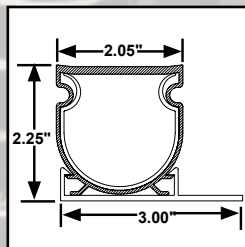

### PAVER DRAIN MODEL NUMBERS

Available colors: White, Gray, and Tan (W,G,T)

Item No.	Length	Packaging
<b>QP-6401</b> (W,G,T)	10 ft.	80 ft./case, eight 10 ft. pcs.

Includes eight connectors (QP-6411-1 or QP-6413-1), 48 securing clips (QP-1003), double-protective tape, and instruction sheet



CONCEPTS IN  
PLASTICS

Quaker Plastics provides a wide range of products to the swimming pool and construction industries: pool steps, deck and paver drains, liner locks and control joints help to provide a complete offering for backyards and patios. Quaker also produces specialty items for industrial and consumer products. Our trusted reputation to provide engineering solutions is backed by a proven and high-quality product line produced with our state-of-the-art manufacturing processes.

Made of all-weather, rigid PVC and available in several designer colors, our drains can match your landscape needs for color and function. The drains are constructed with a concave top for superior drainage and minimal debris collection. Our design provides for less clogging, and for handling more water volume than comparably sized competitive drains. The deck drains can be mounted flush against the wall, and are ready to install with tops and base assembled, screws, connections, protective tape, and instruction sheet included in the packaging.